



## konstrukcja:

Promieniowy wentylator kanałowy. Prostokątna obudowa izolowana akustycznie wykonana z galwanizowanej blachy stalowej, z odchylaną pokrywą serwisową, łatwo demontowalny moduł silnika i wirnika. Obudowa posiada znormalizowane króćce przyłączeniowe z tolerancją ujemną (nypłowe) do podłączenia w systemie okrągłych kanałów wentylacyjnych. Na obudowie przymocowano puszkę przyłączeniową.

## wirnik:

Wyważany dynamicznie wirnik typu F stanowi integralną część silnika (tzw. silnik z wirującą obudową). Łopatki pochylone do przodu wykonane z ocynkowanej galwanicznie blachy stalowej.

## napęd i sterowanie:

Jednofazowy, asynchroniczny silnik elektryczny 230V, 50Hz z wirującą obudową. Silniki posiadają zintegrowane zabezpieczenie termiczne (modele 250/1600, 355 i 400 posiadają wyprowadzone końcówki termokontaktu, które należy podłączyć do odpowiedniego przekaźnika, np. S ET10) i są przystosowane do napięciowej regulacji prędkości obrotowej w pełnym zakresie. Stopień ochrony IP44, klasa izolacji B (modele do wielkości 160 włącznie) oraz F (pozostałe modele).

## maksymalna temperatura pracy:

40 ± 60°C – w zależności od wybranego modelu

## zastosowanie:

Wentylacja ogólna obiektów mieszkalnych, biurowych, przemysłowych i użyteczności publicznej. Ze względu na izolację akustyczną wentylatory ACUBOX są idealne do wentylacji bibliotek, sal konferencyjnych, szkół, szpitali, itp.



## Uchwyt montażowy

Wentylator został wyposażony w zintegrowane uchwyty montażowe, które znacznie ułatwiają montaż do podłoża.

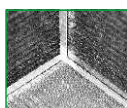

## Izolacja akustyczna

Izolację akustyczną stanowi warstwa 40mm wysokiej jakości wełny kamiennej o gęstości 88 kg/m<sup>3</sup>, która znacznie lepiej absorbuje dźwięki o niskiej częstotliwości. Izolacja spełnia wymogi przeciwpożarowe dla klasy A2 - niepalnej.



## Siatka ochronna

Bezpośrednio na wlocie powietrza do wentylatora znajduje się siatka zabezpieczająca wirnik przed uszkodzeniem na skutek przedostania się ciał obcych do wnętrza wentylatora.



## Klamry zaciskowe

Dzięki zastosowaniu szybkozaciskowych klamr, pokrywę serwisową można zdemontować bez konieczności używania jakichkolwiek narzędzi.

## Wyposażenie



### GS

wyłącznik serwisowy  
str. nr 425



### ETX

plynny reg. obrotów (tyrystorowy)  
str. nr 402



### STR-1

5-bieg. reg. ob. (transformatorowy)  
str. nr 408



### ATR-1

autotransfor. do zab. w szafie ster.  
str. nr 407



### OFK

klamra montażowa  
str. nr 77



### SDS

tłumik kanałowy prosty  
str. nr 82



### FLEXITEC

tłumik kanałowy elastyczny  
str. nr 81



### SG

siatka ochronna  
str. nr 83



### RSK

klapa zwrotna  
str. nr 77



### FBM

filtr kanałowy EU3  
str. nr 75



### FBB

kaseta filtra kieszeniowego  
str. nr 76



### IRIS

przepustnica soczewkowa  
str. nr 80

## tablica doboru akcesoriów dla danego wentylatora ACUBOX.F:

Typ ACUBOX.F	125/300	125/350	150/400	160/400	200/700	250/1100
wyłącznik serwisowy	GS 01	GS 01	GS 01	GS 01	GS 01	GS 01
plynny regulator obrotów (tyrystorowy)	ETX 15	ETX 15	ETX 15	ETX 15	ETX 15	ETX 15
5-bieg. reg. obrotów (transformatorowy)	STR-1-15L22	STR-1-15L22	STR-1-15L22	STR-1-15L22	STR-1-15L22	STR-1-22L22
autotransformator do zab. w szafie ster.	ATR-1-15L25	ATR-1-15L25	ATR-1-15L25	ATR-1-15L25	ATR-1-15L25	ATR-1-25L25
klamra montażowa	OFK 125	OFK 125	OFK 150	OFK 160	OFK 200	OFK 250
tłumik kanałowy prosty	SDS 125	SDS 125	SDS 150	SDS 160	SDS 200	SDS 250
tłumik kanałowy elastyczny	FLEXITEC 125	FLEXITEC 125	FLEXITEC 150	FLEXITEC 160	FLEXITEC 200	FLEXITEC 250
siatka ochronna	SG 125	SG 125	SG 150	SG 160	SG 200	SG 250
klapa zwrotna	RSK 125	RSK 125	RSK 150	RSK 160	RSK 200	RSK 250
filtr kanałowy EU3	FBM 125	FBM 125	FBM 150	FBM 160	FBM 200	FBM 250
kaseta filtra kieszeniowego	FBB 125	FBB 125	FBB 150	FBB 160	FBB 200	FBB 250
przepustnica soczewkowa	IRIS 125	IRIS 125	-	IRIS 160	IRIS 200	IRIS 250

  

Typ ACUBOX.F	250/1600	315/1800	355/2600	400/2700	500/6000
wyłącznik serwisowy	GS 01	GS 01	GS 01	GS 01	GS 01
plynny regulator obrotów (tyrystorowy)	STL 3D	STL 3D	STL 5D	STL 5D	STL 10D
5-bieg. reg. obrotów (transformatorowy)	STR-1-35L22	STR-1-35L22	STR-1-50L22	STR-1-50L22	STR-1-75L22
autotransformator do zab. w szafie ster.	ATR-1-35L25	ATR-1-35L25	ATR-1-50L25	ATR-1-50L25	ATR-1-80L25
klamra montażowa	OFK 250	OFK 315	OFK 355	OFK 400	OFK 500
tłumik kanałowy prosty	SDS 250	SDS 315	SDS 355	SDS 400	SDS 500
tłumik kanałowy elastyczny	FLEXITEC 250	FLEXITEC 315	FLEXITEC 355	FLEXITEC 400	-
siatka ochronna	SG 250	SG 315	SG 355	SG 400	SG 500
klapa zwrotna	RSK 250	RSK 315	RSK 355	RSK 400	-
filtr kanałowy EU3	FBM 250	FBM 315	FBM 355	FBM 400	-
kaseta filtra kieszeniowego	FBB 250	FBB 315	FBB 355	FBB 400	-
przepustnica soczewkowa	IRIS 250	IRIS 315	-	IRIS 400	IRIS 500

## dane techniczne

Typ	$\dot{V}_{max}$ [m <sup>3</sup> /h]	$\Delta p_{max}$ [Pa]	$P_{max}$ [W]	U [V]	$I_{max}$ [A]	RPM <sub>max</sub> [1/min]	$t_{max}$ [°C]	$L_{WA}$ [dB(A)]	$L_{pA}$ [dB(A)]	m [kg]	nr katalogowy
ACUBOX.F 125/300	290	360	100	230	0,5	2650	50	48	41	11,0	11487600
ACUBOX.F 125/350	365	370	110	230	0,5	2700	50	48	41	11,0	11487500
ACUBOX.F 150/400	380	370	115	230	0,5	2690	50	46	39	11,0	11487700
ACUBOX.F 160/400	390	370	110	230	0,5	2610	50	49	42	11,0	11487200
ACUBOX.F 200/700	710	400	170	230	0,8	2730	60	52	45	12,5	11485500
ACUBOX.F 250/1100	1050	440	280	230	1,3	2760	60	52	45	16,5	11485400
ACUBOX.F 250/1600	1560	305	430	230	2,1	1460	40	53	46	28,7	11485900
ACUBOX.F 315/1800	1868	420	570	230	2,4	2840	40	59	52	24,3	11486000
ACUBOX.F 355/2600	2620	512	970	230	4,6	1420	45	57	50	43,0	11486700
ACUBOX.F 400/2700	2720	510	980	230	4,7	1430	50	56	49	43,0	11486800
ACUBOX.F 500/6000	6020	385	1490	230	6,6	1450	40	57	50	67,8	10440900

## wymiary

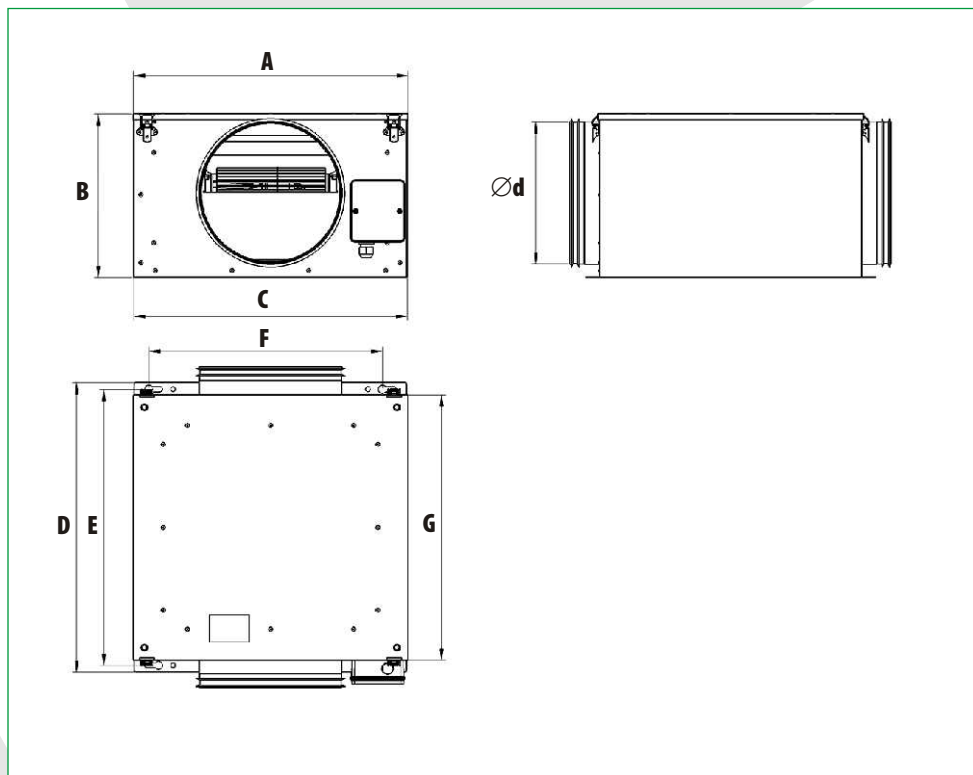

Typ	A [mm]	B [mm]	C [mm]	Ød [mm]	D [mm]	E [mm]	F [mm]	G [mm]
ACUBOX.F 125/300	383	232	380	NW 125	426	384	310	402
ACUBOX.F 125/350	383	232	380	NW 125	426	384	310	402
ACUBOX.F 150/400	383	232	380	NW 150	426	384	310	402
ACUBOX.F 160/400	383	232	380	NW 160	426	384	310	402
ACUBOX.F 200/700	383	286	380	NW 200	428	404	310	384
ACUBOX.F 250/1100	482	287	480	NW 250	508	484	410	466
ACUBOX.F 250/1600	542	386	540	NW 250	558	516	470	534
ACUBOX.F 315/1800	542	386	540	NW 315	558	534	470	516
ACUBOX.F 355/2600	682	491	680	NW 355	698	674	610	656
ACUBOX.F 400/2700	682	491	680	NW 400	698	674	610	656
ACUBOX.F 500/6000	880	587	880	NW 500	-	661	-	-

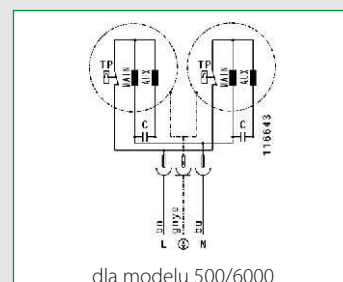
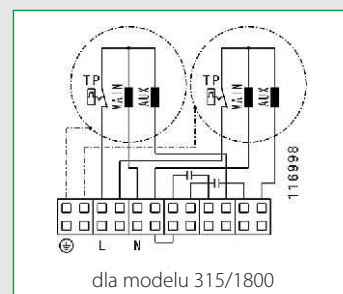
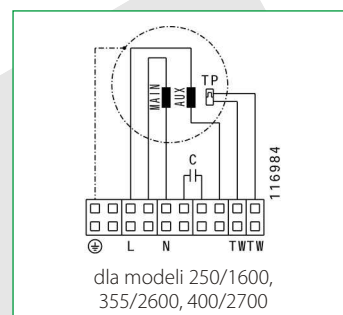
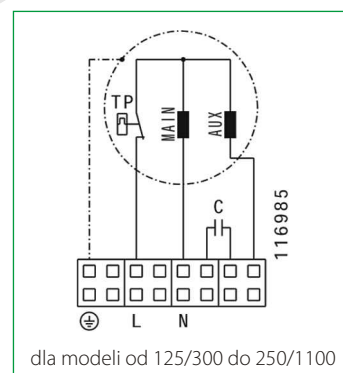

## charakterystyki pracy

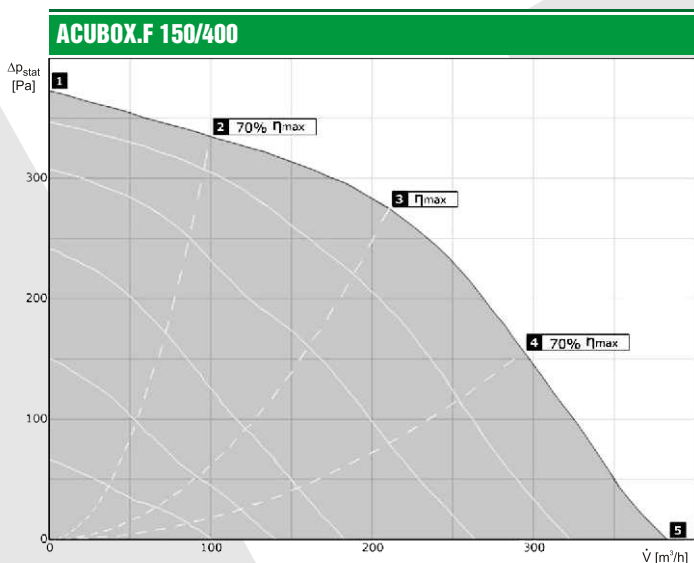
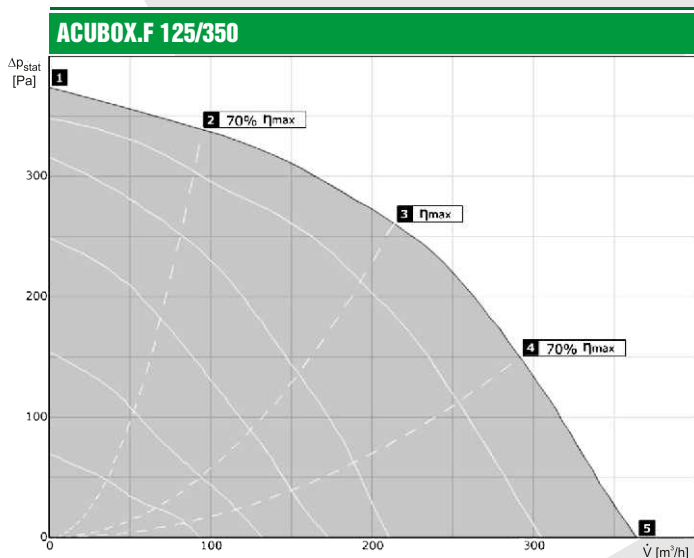
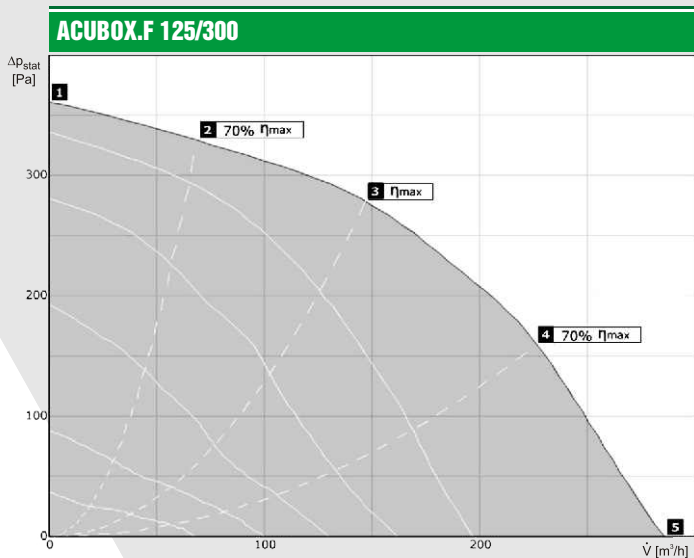

## wartości mocy akustycznej $L_{WA}$ [dB(A)] dla poszczególnych częstotliwości pasm oktaowych [Hz]

Pkt. Pracy	tot	Częstotliwości pasm oktaowych [Hz]							
		63	125	250	500	1000	2000	4000	8000
$L_{WA}$ wlot [dB(A)]									
2	51	45	44	45	43	40	36	30	18
3	51	45	44	44	43	40	36	30	18
4	48	44	42	42	40	36	31	24	11
5	47	42	41	43	37	31	28	22	9
$L_{WA}$ wylot [dB(A)]									
2	66	49	52	56	61	60	57	52	42
3	65	49	52	56	61	60	57	52	42
4	62	46	48	51	58	56	54	49	38
5	60	45	46	49	56	54	53	48	36
$L_{WA}$ od obudowy [dB(A)]									
2	47	41	41	43	39	35	31	24	13
3	48	43	41	43	40	35	31	24	13
4	45	37	40	41	37	32	25	16	-
5	45	37	38	42	34	26	20	11	-

Pkt. Pracy	tot	Częstotliwości pasm oktaowych [Hz]							
		63	125	250	500	1000	2000	4000	8000
$L_{WA}$ wlot [dB(A)]									
2	52	46	47	45	43	41	38	32	21
3	52	45	47	45	43	41	38	32	22
4	50	46	44	42	40	37	34	28	16
5	50	46	45	42	40	35	34	29	16
$L_{WA}$ wylot [dB(A)]									
2	67	49	53	57	62	62	58	54	44
3	66	48	52	56	61	61	58	54	45
4	64	49	50	53	60	59	57	52	42
5	64	50	51	52	60	58	57	53	42
$L_{WA}$ od obudowy [dB(A)]									
2	48	41	43	43	39	36	33	27	16
3	48	41	44	43	38	36	32	26	14
4	46	40	41	40	36	32	26	19	-
5	18	11	-	-	14	-	-	-	-

Pkt. Pracy	tot	Częstotliwości pasm oktaowych [Hz]							
		63	125	250	500	1000	2000	4000	8000
$L_{WA}$ wlot [dB(A)]									
2	51	47	45	44	41	40	38	32	22
3	51	46	44	43	40	40	37	32	22
4	49	44	43	41	38	37	34	30	18
5	51	47	45	43	38	36	35	31	19
$L_{WA}$ wylot [dB(A)]									
2	67	51	53	58	62	62	58	53	44
3	66	50	52	57	61	62	58	53	45
4	65	48	51	55	61	59	56	52	42
5	66	51	53	54	62	60	58	55	45
$L_{WA}$ od obudowy [dB(A)]									
2	47	42	40	41	36	35	33	26	16
3	46	42	39	41	36	35	31	26	16
4	44	39	38	38	34	31	23	18	10
5	45	43	39	38	33	27	22	19	9

## charakterystyki pracy

### ACUBOX.F 160/400



## wartości mocy akustycznej $L_{WA}$ [dB(A)] dla poszczególnych częstotliwości pasm oktaowych [Hz]

Pkt. Pracy	tot	Częstotliwości pasm oktaowych [Hz]							
		63	125	250	500	1000	2000	4000	8000
$L_{WA}$ wlot [dB(A)]									
2	55	51	49	46	44	43	39	34	23
3	55	51	49	46	44	43	40	34	23
4	52	48	46	43	41	40	36	31	19
5	51	48	44	43	38	37	36	31	18
$L_{WA}$ wylot [dB(A)]									
2	68	51	55	61	63	64	59	54	45
3	69	49	56	63	64	65	59	55	46
4	65	50	52	57	60	58	56	52	42
5	65	50	52	54	61	58	57	53	43
$L_{WA}$ od obudowy [dB(A)]									
2	49	43	44	41	38	36	33	27	15
3	49	44	44	41	38	36	33	28	17
4	46	42	41	40	37	34	25	18	-
5	46	42	39						

### ACUBOX.F 200/700

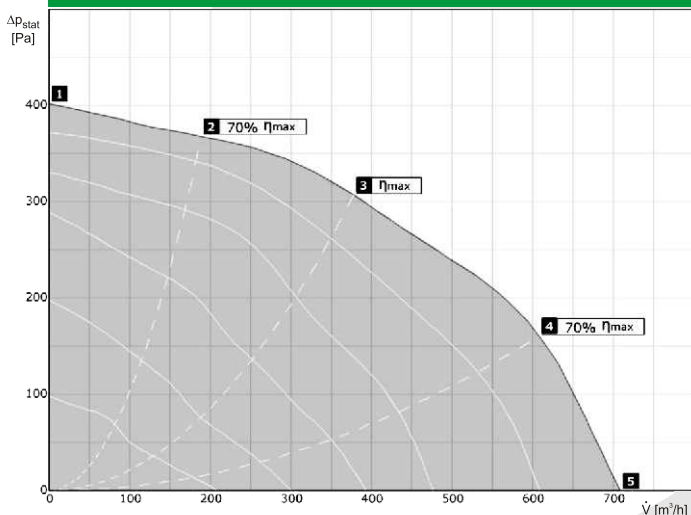

Pkt. Pracy	tot	Częstotliwości pasm oktaowych [Hz]							
		63	125	250	500	1000	2000	4000	8000
$L_{WA}$ wlot [dB(A)]									
2	58	56	52	46	45	41	42	35	24
3	57	55	50	45	45	41	42	35	22
4	55	52	47	44	43	41	42	36	20
5	56	54	48	45	42	41	42	38	25
$L_{WA}$ wylot [dB(A)]									
2	71	58	57	60	66	66	62	57	42
3	71	56	56	60	66	65	62	57	42
4	70	53	54	59	66	64	62	58	44
5	70	55	55	58	66	64	63	59	46
$L_{WA}$ od obudowy [dB(A)]									
2	54	50	50	41	39	38	37	31	23
3	52	50	46	41	39	36	34	28	21
4	50	49	40	39	36	33	26	23	15
5	48	46	40	39	34	32	26	24	14

### ACUBOX.F 250/1100

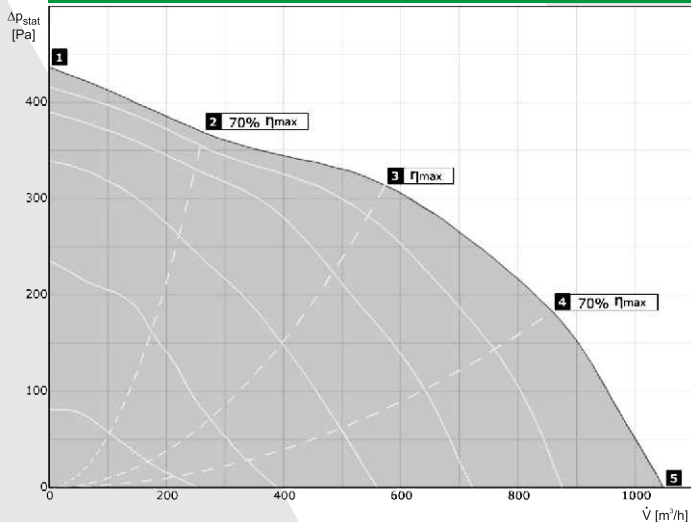

Pkt. Pracy	tot	Częstotliwości pasm oktaowych [Hz]							
		63	125	250	500	1000	2000	4000	8000
$L_{WA}$ wlot [dB(A)]									
2	61	57	57	50	44	44	45	37	26
3	58	54	54	49	43	44	45	37	23
4	57	52	52	50	44	45	47	39	25
5	59	53	54	51	46	46	48	40	27
$L_{WA}$ wylot [dB(A)]									
2	72	58	60	62	67	66	63	58	41
3	73	56	60	64	68	68	66	61	45
4	74	54	59	63	68	69	67	63	47
5	74	55	60	63	69	69	67	64	49
$L_{WA}$ od obudowy [dB(A)]									
2	57	51	55	47	39	37	38	33	24
3	52	47	48	43	39	37	36	31	19
4	50	45	46	42	38	37	34	29	12
5	51	46	48	43	39	37	34	30	14

## charakterystyki pracy

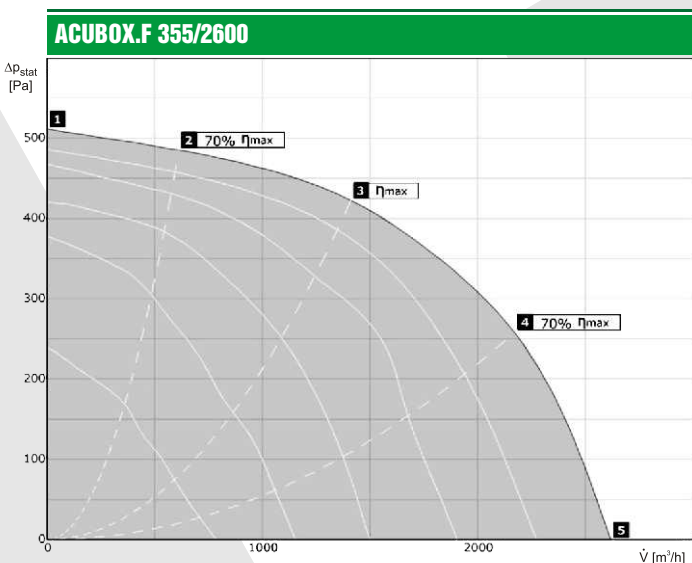
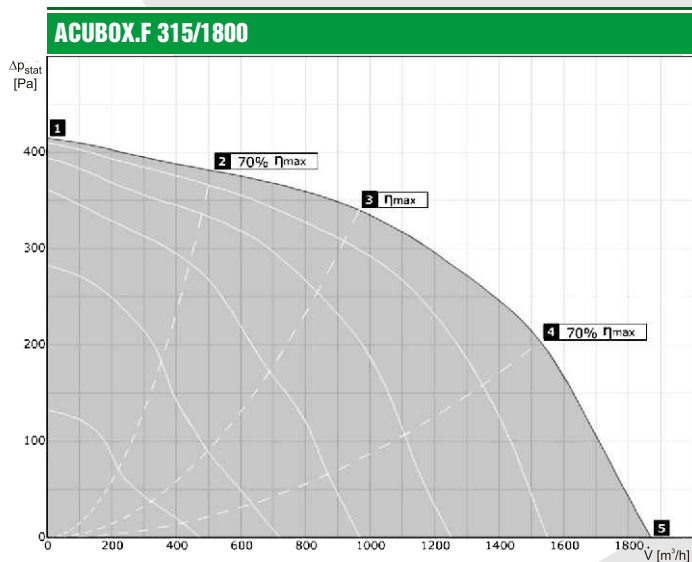
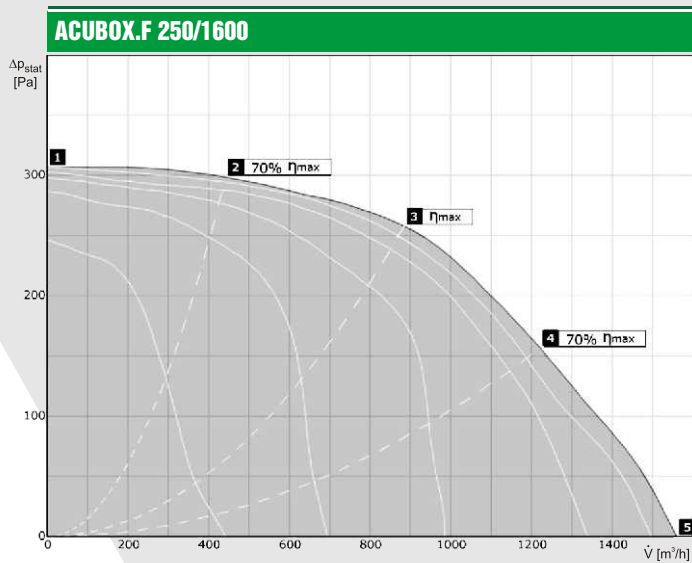

## wartości mocy akustycznej $L_{WA}$ [dB(A)] dla poszczególnych częstotliwości pasm oktaowych [Hz]

Pkt. Pracy	tot	Częstotliwości pasm oktaowych [Hz]							
		63	125	250	500	1000	2000	4000	8000
$L_{WA}$ wlot [dB(A)]									
2	61	59	54	48	43	45	43	36	25
3	59	56	53	50	46	48	46	39	27
4	60	56	55	50	48	51	49	45	30
5	63	57	58	53	52	54	54	47	35
$L_{WA}$ wylot [dB(A)]									
2	69	55	58	60	64	62	62	57	42
3	72	56	59	61	67	65	66	61	46
4	75	57	62	65	70	68	70	65	52
5	78	61	66	68	73	71	73	68	57
$L_{WA}$ od obudowy [dB(A)]									
2	54	48	52	43	37	33	35	29	18
3	53	48	50	44	39	34	35	29	16
4	53	49	50	45	41	35	35	31	15
5	56	52	52	46	43	38	38	35	20

Pkt. Pracy	tot	Częstotliwości pasm oktaowych [Hz]							
		63	125	250	500	1000	2000	4000	8000
$L_{WA}$ wlot [dB(A)]									
2	64	61	55	53	50	53	53	47	35
3	62	57	53	52	50	54	54	48	35
4	62	57	55	54	52	53	54	49	35
5	-	-	-	-	-	-	-	-	-
$L_{WA}$ wylot [dB(A)]									
2	74	61	61	63	69	69	66	62	49
3	75	58	60	63	69	71	68	64	51
4	77	56	60	65	72	72	70	66	54
5	-	-	-	-	-	-	-	-	-
$L_{WA}$ od obudowy [dB(A)]									
2	60	59	51	46	40	40	39	34	25
3	59	57	51	46	40	40	39	34	23
4	57	55	50	46	40	40	38	33	19
5	-	-	-	-	-	-	-	-	-

Pkt. Pracy	tot	Częstotliwości pasm oktaowych [Hz]							
		63	125	250	500	1000	2000	4000	8000
$L_{WA}$ wlot [dB(A)]									
2	63	56	60	49	50	52	51	44	35
3	62	55	58	48	51	52	52	45	35
4	62	55	57	50	53	55	54	47	36
5	66	63	59	51	54	56	57	49	38
$L_{WA}$ wylot [dB(A)]									
2	75	59	65	65	70	68	68	59	48
3	75	58	63	66	70	69	69	61	49
4	78	57	63	68	73	71	72	66	54
5	80	62	67	70	74	73	74	68	57
$L_{WA}$ od obudowy [dB(A)]									
2	59	53	57	45	41	41	43	40	33
3	57	51	54	44	41	40	43	39	32
4	56	52	52	45	42	39	40	33	21
5	61	59	55	47	44	41	41	32	20

## charakterystyki pracy

### ACUBOX.F 400/2700

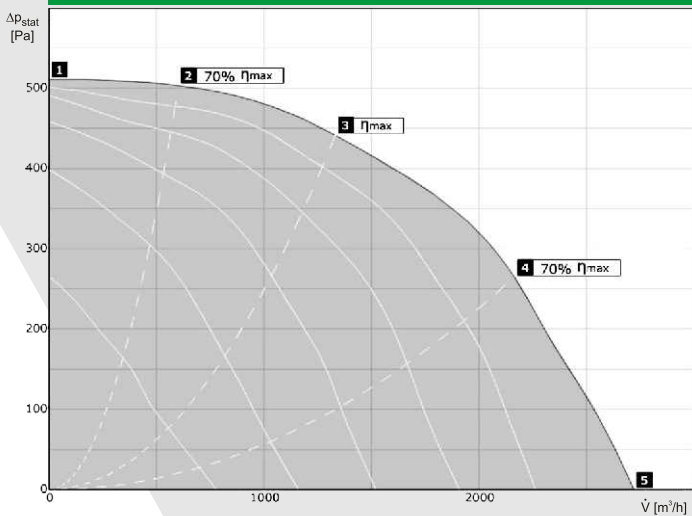

### ACUBOX.F 500/6000

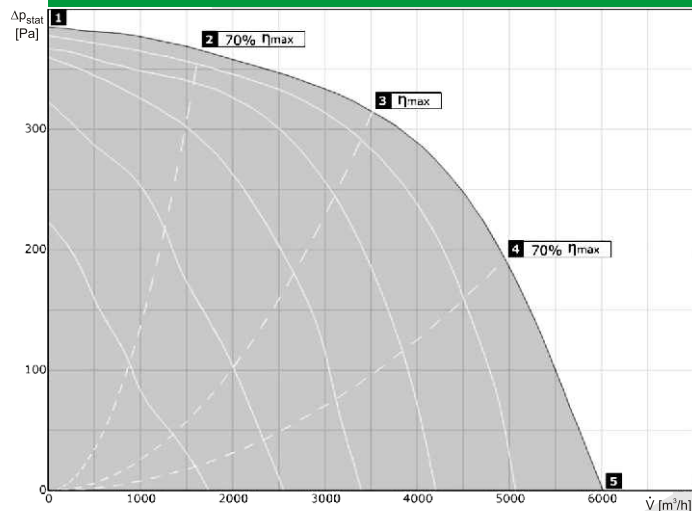

## wartości mocy akustycznej $L_{WA}$ [dB(A)] dla poszczególnych częstotliwości pasm oktaowych [Hz]

Pkt. Pracy	tot	Częstotliwości pasm oktaowych [Hz]							
		63	125	250	500	1000	2000	4000	8000
$L_{WA}$ wlot [dB(A)]									
2	63	55	60	49	52	53	52	44	34
3	64	54	61	48	53	54	53	45	34
4	64	53	59	49	55	57	56	48	37
5	65	59	58	52	56	58	58	51	39
$L_{WA}$ wylot [dB(A)]									
2	74	59	63	65	68	68	67	58	45
3	75	57	62	65	70	69	69	61	48
4	77	57	63	67	72	71	71	64	54
5	79	61	65	69	73	73	73	67	57
$L_{WA}$ od obudowy [dB(A)]									
2	56	52	53	45	42	43	43	36	28
3	56	50	52	44	42	43	44	36	27
4	55	50	51	45	43	44	45	34	18
5	58	55	54	47	45	44	45	35	18

Pkt. Pracy	tot	Częstotliwości pasm oktaowych [Hz]							
		63	125	250	500	1000	2000	4000	8000
$L_{WA}$ wlot [dB(A)]									
2	64	57	56	56	53	52	50	43	21
3	64	58	57	56	54	53	52	45	22
4	66	58	60	58	57	56	56	50	29
5	69	60	63	61	59	59	59	54	33
$L_{WA}$ wylot [dB(A)]									
2	77	58	64	70	72	70	68	63	41
3	78	59	64	70	74	71	69	65	42
4	81	60	68	73	76	76	74	70	49
5	84	63	69	76	78	78	77	72	52
$L_{WA}$ od obudowy [dB(A)]									
2	56	48	51	50	48	45	41	32	11
3	57	49	51	51	49	45	40	32	-
4	58	48	54	51	50	46	41	33	11
5	60	51	56						